



Legacy Mode™

**Backwards Compatibility to
Legacy Systems Designed for
LC24.2 Trend Screenkeys**

CONFIDENTIALITY

This document contains confidential information and is NOT intended for public release. The recipient of the document acknowledges the interest of [E³] Engstler Elektronik Entwicklung GmbH to keep certain aspects of its hardware and software capabilities confidential.

No copy of this document may be released to any third party without the prior written consent of [E³] Engstler Elektronik Entwicklung GmbH.

CONFIDENTIAL

TABLE OF CONTENTS

Confidentiality	2
General Description	4
Product Features	4
Resolution.....	4
RGB Colours.....	4
Colour Calibration.....	4
Self-Initialisation.....	4
Low Power Consumption.....	4
Technical Overview	5
Electrical Specifications	6
Interfacing	7
Contact Terminals.....	7
Block Diagram	8
Serial Protocols	9
Advanced Technology™ Mode.....	9
Legacy Mode™.....	9
Data Byte Format.....	11
Bit-Timing.....	11
Parity Bit.....	11
Bit Mapping	12
Bitmapping for SA3216.....	12
Bitmapping for SA3624.....	13
Legacy Mode™ Considerations	14
Colour Register (0xED).....	14
Activation of SA Colours.....	14
Frequency Value Table (0xEE).....	14
MUX Register (0xEF & 0xFF).....	14
SA Colour Table	15
Controlling SA Switch Arrays	16
Notices.....	17
Copyright Notice.....	17
Technical Notice.....	17
Warranty Disclaimer.....	17
Ordering information	18
Change History.....	18

GENERAL DESCRIPTION

The SA switch family includes the SA3216, SA3624 and SA6432 LCD Keyswitches with command driven serial interfaces. They integrate a graphical liquid crystal display with **RGB** backlighting in a keyswitch. The SA keys are controlled via a serial interface to the integrated *Advanced Technology*[™] electronics, which control the interface, display and backlighting.

SA keys self-initialise without external setup commands. Data only needs to be transmitted when a change is made to the display or background colours. Only six contact terminals are needed to provide power, clock and data lines as well as switch contacts. The contact pins of the internal switch are isolated from the internal electronics. The clock does not have to be permanent. There will be no harm to the SA switches if no clock is applied.

PRODUCT FEATURES

Resolution

Three different resolutions available:	SA3216	32x16 pixels
	SA3624	36x24 pixels
	SA6432	64x32 pixels (Legacy Mode[™] not supported)

RGB Colours

SA3216, **SA3624** and **SA6432** keys support 64 **RGB** colours in Legacy Mode[™] and over 1 million **RGB** colours in *Advanced Technology*[™] mode.

Colour Calibration

No colour sorting due to *Advanced Technology*[™] electronics. The **RGB** backlighting of all keyswitches is calibrated for maximum uniformity.

Self-Initialisation

All keys self-initialise. No external setup commands required.

Low Power Consumption

Less than 65mA maximum current is needed when bright white backlighting is selected. Typical value is less than 25mA with one of the **RGB** colours.

TECHNICAL OVERVIEW

Features	SA3216	SA3624	SA6432
Resolution	32 x 16	36 x 24	64 x 32
RGB backlight colours	64 RGB colours		
Interfaces	Synchronous serial 8-bit interfaces		
	<i>Legacy Mode</i> [™] Synchronous serial 12-bit interface with additional 4 stop bits		
External clock	For data transmission only 60 kHz up to 2 MHz May be permanent		
Self-initialisation	Yes		
Maximum speed	2 MBaud		
Operating supply	4.9 V to 5.1 V		
Keyswitch type	tactile, 2.5 mm travel with over travel protection		
Keyswitch life time	> 3.0 million cycles		
Contact resistance	< 200 Ohm		
Operating temperature	0°C to 55°C		
Storage temperature	-20°C to 65°C		

For further details please see the “SA Technical Datasheet”.

ELECTRICAL SPECIFICATIONS

Operating voltage	4.9 V to 5.1 V
Current consumption	max. 65 mA; typ. < 30 mA; min. 8 mA
Contact resistance	< 200 Ohm
Insulating resistance	> 100 MOhm

Symbol	Parameter	Min.	Typ.	Max.	Unit
$V_{DD}^{*1)}$	Operating voltage	4.7		5.25	V
$I_{DD}^{*2)}$	Supply current	8	<20	65	mA
V_{IN}	Input voltage on any pin			$V_{SS} - 0.3 - V_{DD} + 0.3$	V
I_{DIO}	Output data current sunk/source			+/- 5	mA
I_{CIO}	Output clock current sunk/source			+/- 5	mA
V_{IL}	Input low level voltage	$V_{SS} - 0.3$		$0.3 \times V_{DD}$	V
V_{IH}	Input high level voltage	$0.7 \times V_{DD}$		$V_{DD} + 0.3$	V
C_{CIO}	I/O clock pin capacitance		10		pF
$C_{DIO}^{*3)}$	I/O data pin capacitance		230		pF

*1) Voltage range to ensure proper display contrast restricted to 4.9V to 5.1V.

*2) Special power saving models available on request.

*3) The I/O data pin capacitance may be reduced in future products without notice.

INTERFACING

Contact Terminals

Pin	Symbol	Description	Comment
1	GND	negative (ground) power terminal	0.0 V
2	+ 5V	positive power terminal	+4.9 V – +5.1 V
3	CLOCK	clock line to synchronize data write and for internal use	60 kHz – 2 MHz HIGH when inactive
4	DATA	command and data line to internal <i>Advanced Technology™</i> electronics	HIGH when inactive; see data format for details
5	SW1	switch contact	contact resistance < 200 Ohm
6	SW2	switch contact	contact resistance < 200 Ohm

NOTE: During power up both clock and data line must be set to HIGH

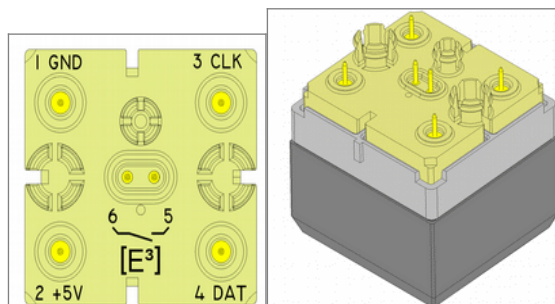

Pin View (terminal name and number are also marked on the keyswitch)

BLOCK DIAGRAM

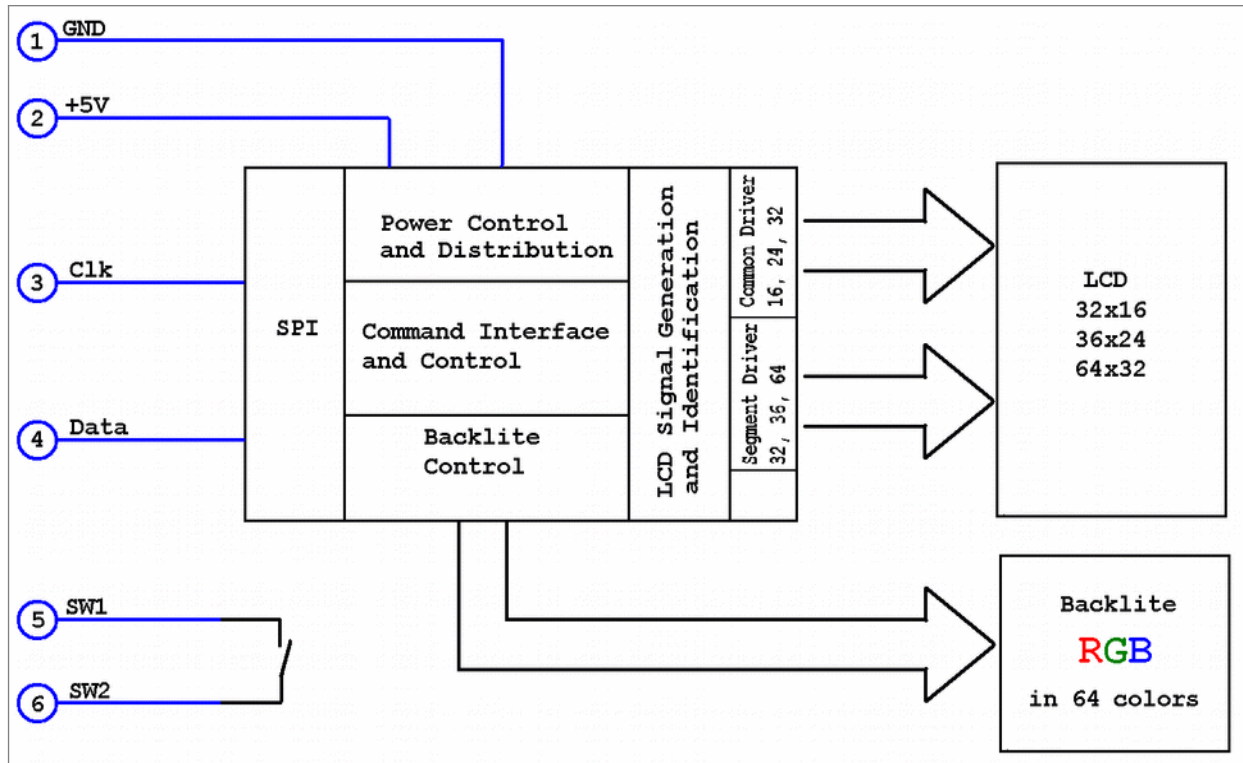

SERIAL PROTOCOLS

The SA3216, SA3624 and SA6432 keyswitches are connected to the controlling central processing unit via a 2 wire serial connection.

Currently, the SA switches support **two different** protocols:

- **Legacy Mode™** (SA3216, SA3624 and specifically enabled firmware versions only! SA6432 typically are not Legacy Mode™ enabled.)
- **Advanced Technology™ Mode**

Feature	Legacy Mode™	Advanced Technology™ Mode
Clock Frequency	64 kHz to 2 MHz	up to 2 MHz
Permanent Clock	Yes	No
Data Word Size	12 bit	8 bit
Internal Serial Number	No	Yes*

* To take advantage of these advanced functions your hardware must ensure that the SA keys are actively driving the serial data lines in **Advanced Technology™** mode.

Advanced Technology™ Mode

This is the standard mode for controlling SA keyswitches and provides full access to all capabilities of the SA3216, SA3624 and SA6432 keys. The details of this control protocol are documented in “SA Technical Data Sheet”.

Legacy Mode™

(SA3216, SA3624 and specifically enabled firmware versions SA6432 only!)

Legacy Mode™ applies only to the use of SA3216 and SA3624 keyswitches in legacy systems and specifically enabled firmware versions of SA6432 keyswitches. The specifically enabled SA6432 switches automatically emulate the SA3216 resolution, while in **Legacy Mode™**. Full functionality in SA mode is still available by command with these special enabled firmware versions.

The Legacy Mode™ is supported in order to ease the transition to the new possibilities of the SA switches in existing hardware environments. The intelligent electronics of the SA switches detect the existing protocol and automatically convert the data into the data stream that is required for SA switches. In order to make a system compatible with the **Legacy Mode™** it may be necessary to adjust the clock frequency and/or to increase the transfer bit count per data word.

If you have questions regarding the implementation of **Legacy Mode™**, please contact your local [E³]® distributor or [E³]®’s R&D department directly at techsupport@e3-keys.com.

The clock frequency can be between 64 kHz and 2 MHz. To put the SAxxxx switches in **Legacy Mode™**, the switch is addressed by transmitting a start-word (always 0x00) on the serial line. This start word must have parity set according to the specifications found in the following paragraph and the format has to be 16-bit with an additional pause of 2µsec on the data line.

After the start-byte, one of the following commands is expected:

Data	Description	Data Size
Command 0x80	to type pixel data into RAM	max. 64 bytes (SA3216) or max. 108 bytes (SA3624)
Command 0xED	to type color value into register	1 byte
Command 0xEE	Not supported – ignored	1 byte
Command 0xEF	Not supported - ignored	2 bytes

The data bytes follow the command, up to a maximum of 64 or 108 bytes for command 0x80, or otherwise one or two bytes per command.

SAxxxx keyswitches will automatically time out 2.5ms after last valid data transmission. An end byte is not required nor supported and will be ignored.

Note: **The order Start Byte, Command Byte, Data Byte, and End Byte must be adhered to. Since the data transfer to the SAxxxx Keyswitch is unidirectional in Legacy Mode™, no values can be read from the display. The commands to set the Frequency and MUX registers will be ignored since SAxxxx Keyswitches do not need any external initialization.**

The next StartByte following an end of transmission should not be sent prior to 2.5 ms of inactivity on the data line. The SAxxxx keyswitch will automatically end any communication in Legacy Mode™ by entering a time-out condition which will occur within max. 2.5 ms after the last received data word.

Despite the restriction in the note above, a permanent data stream to the SAxxxx keys is possible since the internal memory of the SAxxxx keys allows for write and read at the same time. This will, therefore, not disturb the display. This is a feature especially used in environments in which the switches may be exchanged while the system is still in operation (hot swap). All SAxxxx switches are hot-swappable as required for military applications. If you intend to implement hot-swapping, please allow for a 10ms pause between commands to ensure proper housekeeping including the control of the LEDs.

Data Byte Format

In Legacy Mode™ 16 bits are required for the transmission of a data word.

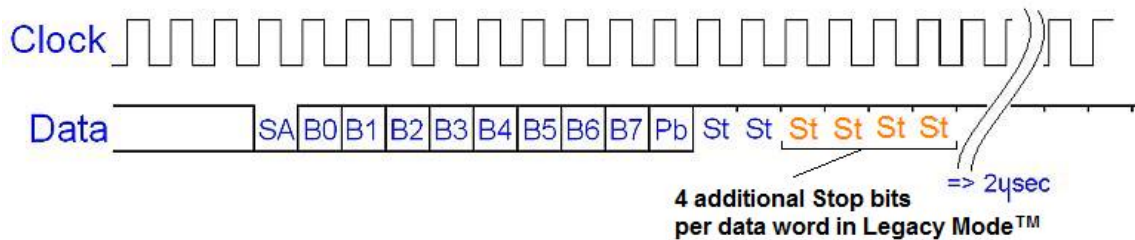

Start bit low SA
 Data bit low / high b0 - b7 (LSB first, MSB last)
 Parity bit low / high Pb
 6 Stop bits high SE

pause of 2µs

Note: In order to be backwards compatible to legacy systems 4 Stop Bits MUST be added to each data word in Legacy Mode™. The original legacy protocol only has 12 bits. The additional stop bits are necessary due to the differences in the legacy and SA switch electronics.

After the 16th bit there must be no Start bit for at least 2µs, while clock can still be generated.

Bit-Timing

For serial data transmission to the display, the following conditions must be adhered to

Clock frequency max	Fmax	2 MHz
Clock frequency min	Fmin	64 kHz
Clock phase low max	Tcpl	31 µs
Clock phase low min	Tcpl	100 ns
Clock phase high max	Tcph	31 µs
Clock phase high min	Tcph	100 ns
Hold data min	Thold	10 ns
Setup data min	Tsu	40 ns

Parity Bit

The parity bit position is only used to validate the Start Byte. The parity position in a start byte must be set to "0" in order to be accepted as a Start Byte. In all other bytes this position is ignored.

Note: After the last data word there must be a pause of more than 2.5ms prior to the next command.

BIT MAPPING

Each bit in the data stream corresponds to a pixel in the display area. A 1-bit represents a black pixel, a 0-bit a light pixel.

The allocation is shown in the following table. The upper line is the Byte number; the lower line shows the corresponding bits per pixel. The following table is for SA3216 and specifically enabled SA6432 keyswitches in **Legacy Mode™**. For the bitmapping in SA mode please refer to the **SA Technical Datasheet**.

Bitmapping for SA3216

B00	b0 b1 b2 b3 b4 b5 b6 b7	B01	b0 b1 b2 b3 b4 b5 b6 b7	B02	b0 b1 b2 b3 b4 b5 b6 b7	B03	b0 b1 b2 b3 b4 b5
B04	b0 b1 b2 b3 b4 b5 b6 b7	B05	b0 b1 b2 b3 b4 b5 b6 b7	B06	b0 b1 b2 b3 b4 b5 b6 b7	B07	b0 b1 b2 b3 b4 b5
B08	b0 b1 b2 b3 b4 b5 b6 b7	B09	b0 b1 b2 b3 b4 b5 b6 b7	B10	b0 b1 b2 b3 b4 b5 b6 b7	B11	b0 b1 b2 b3 b4 b5
B12	b0 b1 b2 b3 b4 b5 b6 b7	B13	b0 b1 b2 b3 b4 b5 b6 b7	B14	b0 b1 b2 b3 b4 b5 b6 b7	B15	b0 b1 b2 b3 b4 b5
B16	b0 b1 b2 b3 b4 b5 b6 b7	B17	b0 b1 b2 b3 b4 b5 b6 b7	B18	b0 b1 b2 b3 b4 b5 b6 b7	B19	b0 b1 b2 b3 b4 b5
B20	b0 b1 b2 b3 b4 b5 b6 b7	B21	b0 b1 b2 b3 b4 b5 b6 b7	B22	b0 b1 b2 b3 b4 b5 b6 b7	B23	b0 b1 b2 b3 b4 b5
B24	b0 b1 b2 b3 b4 b5 b6 b7	B25	b0 b1 b2 b3 b4 b5 b6 b7	B26	b0 b1 b2 b3 b4 b5 b6 b7	B27	b0 b1 b2 b3 b4 b5
B28	b0 b1 b2 b3 b4 b5 b6 b7	B29	b0 b1 b2 b3 b4 b5 b6 b7	B30	b0 b1 b2 b3 b4 b5 b6 b7	B31	b0 b1 b2 b3 b4 b5
B32	b0 b1 b2 b3 b4 b5 b6 b7	B33	b0 b1 b2 b3 b4 b5 b6 b7	B34	b0 b1 b2 b3 b4 b5 b6 b7	B35	b0 b1 b2 b3 b4 b5
B36	b0 b1 b2 b3 b4 b5 b6 b7	B37	b0 b1 b2 b3 b4 b5 b6 b7	B38	b0 b1 b2 b3 b4 b5 b6 b7	B39	b0 b1 b2 b3 b4 b5
B40	b0 b1 b2 b3 b4 b5 b6 b7	B41	b0 b1 b2 b3 b4 b5 b6 b7	B42	b0 b1 b2 b3 b4 b5 b6 b7	B43	b0 b1 b2 b3 b4 b5
B44	b0 b1 b2 b3 b4 b5 b6 b7	B45	b0 b1 b2 b3 b4 b5 b6 b7	B46	b0 b1 b2 b3 b4 b5 b6 b7	B47	b0 b1 b2 b3 b4 b5
B48	b0 b1 b2 b3 b4 b5 b6 b7	B49	b0 b1 b2 b3 b4 b5 b6 b7	B50	b0 b1 b2 b3 b4 b5 b6 b7	B51	b0 b1 b2 b3 b4 b5
B52	b0 b1 b2 b3 b4 b5 b6 b7	B53	b0 b1 b2 b3 b4 b5 b6 b7	B54	b0 b1 b2 b3 b4 b5 b6 b7	B55	b0 b1 b2 b3 b4 b5
B56	b0 b1 b2 b3 b4 b5 b6 b7	B57	b0 b1 b2 b3 b4 b5 b6 b7	B58	b0 b1 b2 b3 b4 b5 b6 b7	B59	b0 b1 b2 b3 b4 b5
B60	b0 b1 b2 b3 b4 b5 b6 b7	B61	b0 b1 b2 b3 b4 b5 b6 b7	B62	b0 b1 b2 b3 b4 b5 b6 b7	B63	b0 b1 b2 b3 b4 b5

Bitmapping for SA3624

B4	B3	B2	B1	B0
b3 b2 b1 b0	b7 b6 b5 b4	b3 b2 b1 b0	b7 b6 b5 b4	b3 b2 b1 b0
B8	B7	B6	B5	B4
b7 b6 b5 b4	b3 b2 b1 b0	b7 b6 b5 b4	b3 b2 b1 b0	b7 b6 b5 b4
B13	B12	B11	B10	B9
b3 b2 b1 b0	b7 b6 b5 b4	b3 b2 b1 b0	b7 b6 b5 b4	b3 b2 b1 b0
B17	B16	B15	B14	B13
b7 b6 b5 b4	b3 b2 b1 b0	b7 b6 b5 b4	b3 b2 b1 b0	b7 b6 b5 b4
B22	B21	B20	B19	B18
b3 b2 b1 b0	b7 b6 b5 b4	b3 b2 b1 b0	b7 b6 b5 b4	b3 b2 b1 b0
B26	B25	B24	B23	B22
b7 b6 b5 b4	b3 b2 b1 b0	b7 b6 b5 b4	b3 b2 b1 b0	b7 b6 b5 b4
B31	B30	B29	B28	B27
b3 b2 b1 b0	b7 b6 b5 b4	b3 b2 b1 b0	b7 b6 b5 b4	b3 b2 b1 b0
B35	B34	B33	B32	B31
b7 b6 b5 b4	b3 b2 b1 b0	b7 b6 b5 b4	b3 b2 b1 b0	b7 b6 b5 b4
B40	B39	B38	B37	B36
b3 b2 b1 b0	b7 b6 b5 b4	b3 b2 b1 b0	b7 b6 b5 b4	b3 b2 b1 b0
B44	B43	B42	B41	B40
b7 b6 b5 b4	b3 b2 b1 b0	b7 b6 b5 b4	b3 b2 b1 b0	b7 b6 b5 b4
B49	B48	B47	B46	B45
b3 b2 b1 b0	b7 b6 b5 b4	b3 b2 b1 b0	b7 b6 b5 b4	b3 b2 b1 b0
B53	B52	B51	B50	B49
b7 b6 b5 b4	b3 b2 b1 b0	b7 b6 b5 b4	b3 b2 b1 b0	b7 b6 b5 b4
B58	B57	B56	B55	B54
b3 b2 b1 b0	b7 b6 b5 b4	b3 b2 b1 b0	b7 b6 b5 b4	b3 b2 b1 b0
B62	B61	B60	B59	B58
b7 b6 b5 b4	b3 b2 b1 b0	b7 b6 b5 b4	b3 b2 b1 b0	b7 b6 b5 b4
B67	B66	B65	B64	B63
b3 b2 b1 b0	b7 b6 b5 b4	b3 b2 b1 b0	b7 b6 b5 b4	b3 b2 b1 b0
B71	B70	B69	B68	B67
b7 b6 b5 b4	b3 b2 b1 b0	b7 b6 b5 b4	b3 b2 b1 b0	b7 b6 b5 b4
B76	B75	B74	B73	B72
b3 b2 b1 b0	b7 b6 b5 b4	b3 b2 b1 b0	b7 b6 b5 b4	b3 b2 b1 b0
B80	B79	B78	B77	B76
b7 b6 b5 b4	b3 b2 b1 b0	b7 b6 b5 b4	b3 b2 b1 b0	b7 b6 b5 b4
B85	B84	B83	B82	B81
b3 b2 b1 b0	b7 b6 b5 b4	b3 b2 b1 b0	b7 b6 b5 b4	b3 b2 b1 b0
B89	B88	B87	B86	B85
b7 b6 b5 b4	b3 b2 b1 b0	b7 b6 b5 b4	b3 b2 b1 b0	b7 b6 b5 b4
B94	B93	B92	B91	B90
b3 b2 b1 b0	b7 b6 b5 b4	b3 b2 b1 b0	b7 b6 b5 b4	b3 b2 b1 b0
B98	B97	B96	B95	B94
b7 b6 b5 b4	b3 b2 b1 b0	b7 b6 b5 b4	b3 b2 b1 b0	b7 b6 b5 b4
B103	B102	B101	B100	B99
b3 b2 b1 b0	b7 b6 b5 b4	b3 b2 b1 b0	b7 b6 b5 b4	b3 b2 b1 b0
B107	B106	B105	B104	B103
b7 b6 b5 b4	b3 b2 b1 b0	b7 b6 b5 b4	b3 b2 b1 b0	b7 b6 b5 b4

LEGACE MODE™ CONSIDERATIONS

Colour Register (0xED)

	B7	B6	B5	B4	B3	B2	B1	B0
Color	red	red	green	green	red	red	green	green
Function	dark / bright	dark / bright	dark / bright	dark / bright	on / off	on / off	on / off	on / off

Combinations of red and green are possible by setting the corresponding bits in the color register (0xED). The following table shows some possible values for backlighting colors:

Legacy Mode™ colour scheme	HEX Value	Binary Value
off	0x00	00000000
dark green	0x03	00000011
bright green	0x33	00110011
dark red	0x0C	00001100
bright red	0xCC	11001100
dark orange	0x0F	00001111
bright orange	0xFF	11111111
greenish orange	0x3F	00111111
reddish orange	0xCF	11001111

Activation of SA Colours

To activate access to the SA Colour range please use the following commands embedded in the colour settings:

Special embedded Colour Commands	HEX Value	Binary Value
Switch to SA Colour scheme	0xC0	11000000
Switch to Legacy Mode™ colour scheme	0x80	10000000

Frequency Value Table (0xEE)

All SAxxxx switches are using internal generated clock and do not detect the external clock automatically. Therefore there will be no harm if no clock is applied.

































































MUX Register (0xEF & 0xFF)

All SAxxxx switches self-initialise the MUX Register. The commands will be ignored.

SA COLOUR TABLE

The following SA Colours are also available in special enabled firmware versions:

The colour approximations for SA3216, SA3624 & SA6432 keys are shown in following colour table. This table is intended for illustration purposes only. The actual display colours on the LCD display with LED backlighting may be different.

	000000		010000		100000		110000
	000001		010001		100001		110001
	000010		010010		100010		110010
	000011		010011		100011		110011
	000100		010100		100100		110100
	000101		010101		100101		110101
	000110		010110		100110		110110
	000111		010111		100111		110111
	001000		011000		101000		111000
	001001		011001		101001		111001
	001010		011010		101010		111010
	001011		011011		101011		111011
	001100		011100		101100		111100
	001101		011101		101101		111101
	001110		011110		101110		111110
	001111		011111		101111		111111

CONTROLLING SA SWITCH ARRAYS

Below are sample schematics for controlling one or sixteen SA keyswitches in an array using a PIC16F62X controller to illustrate the simplicity of the control circuitry. Further descriptions including sources are available under the **Application Notes** at our website at www.e3-keys.com.

For additional technical support with your own design implementation, please contact your local [E³][®] distributor or [E³][®] at techsupport@e3-keys.com.

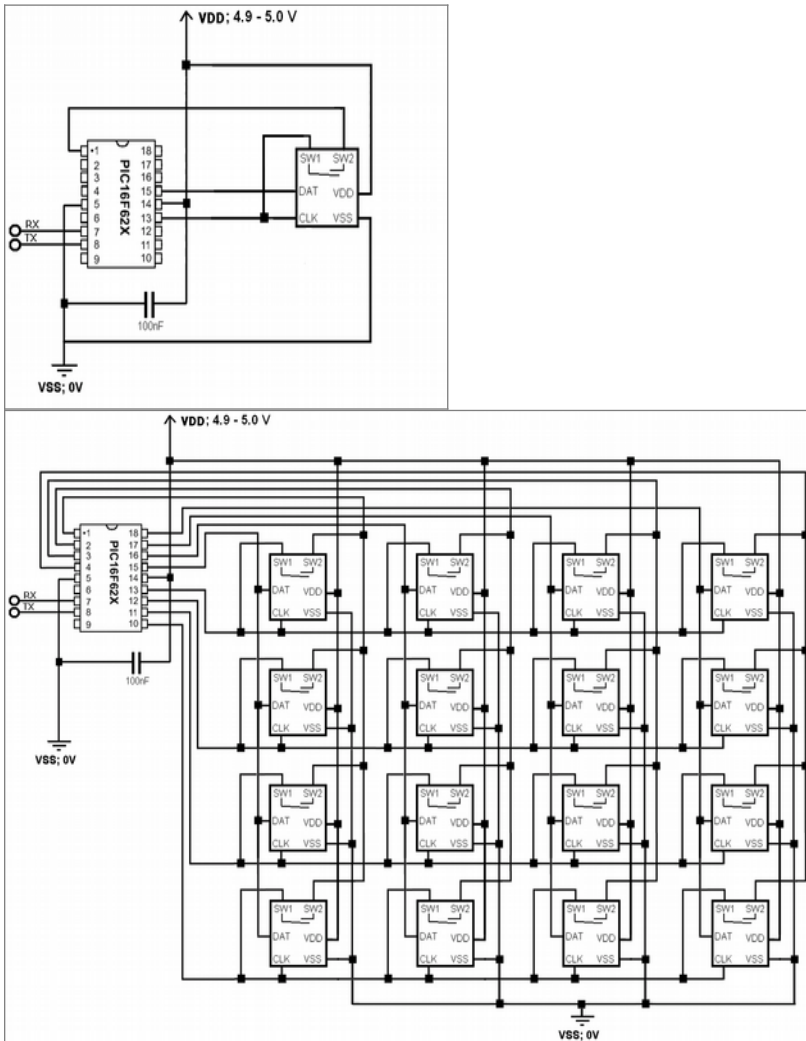

In the above examples the clock and data signals are generated on the corresponding I/O pins of the PIC controller.

Notices

Copyright Notice

© 2003-2024 Copyright [E³] Engstler Elektronik Entwicklung GmbH. All rights reserved.

[E³][®] is a registered trademark of [E³][®], *The Third Evolution*[™], *Advanced Technology*[™] and *Legacy Mode*[™] are trademarks of [E³][®]. *The Keys to Intelligence*[™] is a trademark of I/O Universal Technologies, Inc. used with permission. All other trademarks are property of their respective owners.

No part of this publication may be copied, photocopied, reproduced, translated or reduced to any electronic medium or machine-readable form without the expressed written consent of [E³][®] Engstler Elektronik Entwicklung GmbH.

Technical Notice

This datasheet is intended for technically qualified personnel trained in the field of electronics.

The knowledge of electronics and the technically correct implementation of the content of this datasheet are required for problem free installation, implementation and safe operation of the described product. Only qualified personnel have the required know-how to implement the specifications given in this data sheet.

For clarity, not all details regarding the product or its implementation, installation, operation, or maintenance have been included. Should you require additional information or further assistance, please contact your local [E³][®] distributor or [E³] Engstler Elektronik Entwicklung GmbH at techsupport@e3-keys.com. You may also visit our website at www.e3-keys.com.

Warranty Disclaimer

[E³] ENGSTLER ELEKTRONIK ENTWICKLUNG GMBH GRANTS NO WARRANTY WITH RESPECT TO THIS DATA SHEET, NEITHER EXPLICIT NOR IMPLIED, AND IT IS NOT LIABLE FOR DIRECT OR INDIRECT DAMAGES. SOME STATES DO NOT GRANT THE EXCLUSION OF INCIDENTAL OR CONSEQUENTIAL DAMAGES AND, THEREFORE, THIS STATEMENT MAY NOT BE VALID IN SUCH CASES.

This data sheet has been produced with all due care. However, since errors cannot be excluded, [E³] Engstler Elektronik Entwicklung GmbH does not grant any warranty or accept any legal responsibility or liability in any form for erroneous statements herein.

ORDERING INFORMATION

Part Number	Description
SA3216-B	SA pushbutton keyswitch with 32x16 pixel display Backlit in 64 RGB colours Black housing (RAL 9005)
SA3624-B	SA pushbutton keyswitch with 36 x 24 pixel display Backlit in 64 RGB colours Black housing (RAL 9005)
SA6432-B	SA pushbutton keyswitch with 64 x 32 pixel display Backlit in 64 RGB colours Black housing (RAL 9005)

Change History

Version	Date	Comments
1.0	06/06/04	Initial release of document
1.1	06/29/04	Bitmapping for SA3624 added
1.2	07/28/04	Data Byte Format Graph corrected; edited
1.3	01/08/09	108 versus 64 Data bytes in SA3624 push buttons; TMP range
1.4	09/11/15	Legacy protocol requirement for 4 additional stop bits
1.5	09/16/15	Clock line set to HIGH when inactive; Clock and data line HIGH during power up
1.6	09/13/18	16 byte protocol table corrected
1.7	06/30/20	New Formatting
2.0	06/07/22	Updated release version
2.1	10/24/24	New corporate address

[E³] Engstler Elektronik Entwicklung GmbH
Auweg 27 • 63920 Grossheubach • Germany

WWW.E3-KEYS.COM