



# The Third Evolution™



Programmable,  
**RGB**-backlit  
LCD Keyswitches

## SB6432

Technical Datasheet



© 2006-2008 copyright [E³] Engstler Elektronik Entwicklung GmbH.  
All rights reserved.

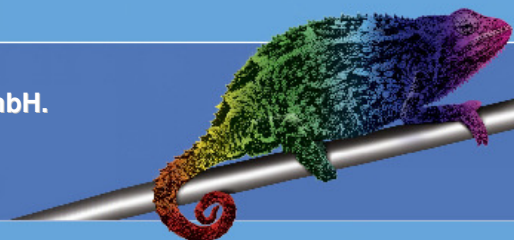

# SB6432

## Technical Datasheet



intentionally left blank

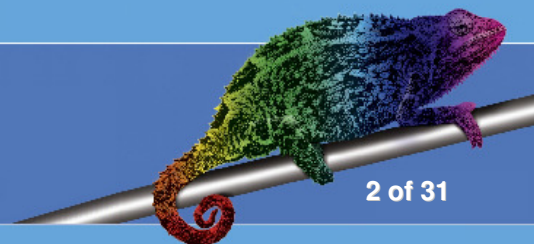



# Table of Content

Table of Content .....	3
General Description .....	5
Innovative Product Features .....	5
Resolution .....	5
RGB Colors .....	5
Color Calibration.....	5
Self-Initialisation .....	5
Enhanced Command Set .....	5
Improved Durability .....	6
Mounting Methods.....	6
Low Power Consumption.....	6
Technical Overview.....	7
SB6432.....	8
Dimensions .....	8
Keypad .....	8
Layout .....	9
Drill Masks.....	9
Mounting Methods.....	10
Liquid Crystal Display .....	11
Environmental Specifications.....	12
Electrical Specifications.....	12
Interfacing SB6432 .....	13
Contact Terminals .....	13
Block Diagram .....	14
Serial Protocols .....	15
Legacy Mode™ .....	15
Advanced Technology™ Mode .....	16
Timing Diagram .....	16
Command Set .....	17
Synchronous Protocol.....	17

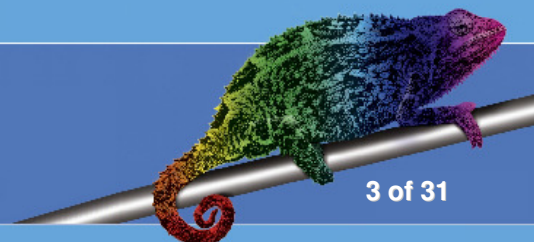

# SB6432

## Technical Datasheet

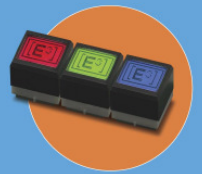

Command and Data Formats.....	17
Commands for mixed use with/without permanent clock.....	18
Additional Commands only available in keys with Enhanced Command Set.....	20
Command Examples.....	22
Bit / Pixel Mapping .....	24
Display Memory – Internal RAM Structure.....	24
Bit/Pixel Mapping Table for SB6432 .....	25
Controlling SB Switch Arrays .....	26
Order Information.....	27
Change History .....	28
Notices.....	29
Copyright Notice.....	29
Technical Notices .....	29
Life Support Applications .....	29
Flammability Ratings .....	30
Warranty Disclaimer .....	30
Contact Information.....	31

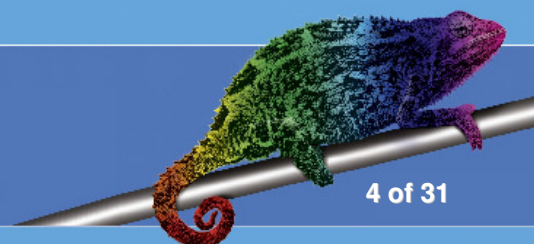



## General Description

The SB6432 switch is a programmable LCD keyswitch with command-driven serial interfaces. The SB6432 integrates a graphical liquid crystal display with **RGB** backlighting in a keyswitch. The SB6432 keys are controlled via a serial interface to the integrated *Advanced Technology*<sup>™</sup> electronics, which control the interface, display and backlighting. The SB6432 self-initialises without external setup commands. Data only needs to be transmitted when a change is made to the display or background colors. Only six contact terminals are needed to provide power, clock and data lines as well as switch contacts. The contact pins of the internal switch are isolated from the internal electronics.

## Innovative Product Features

### Resolution

Three different resolutions available: **SB6432**      **64x32 pixels**

### RGB Colors

**SB6432** supports over 10,000 **RGB** colors.

### Color Calibration

No color sorting due to *Advanced Technology*<sup>™</sup> electronics. The **RGB** backlighting of all keyswitches is calibrated for maximum uniformity.

### Self-Initialisation

All keys self-initialise. No external setup commands required.

### Enhanced Command Set

- ✓ Write Display data with 8 data bits per transmitted data byte
- ✓ Turn Display OFF, while maintaining bitmap
- ✓ Turn Display ON; restoring last transferred bitmap
- ✓ Additional colour command including more than 100 brightness settings
- ✓ Grouping of keys for simultaneous addressing and changing of colour settings (flashing)

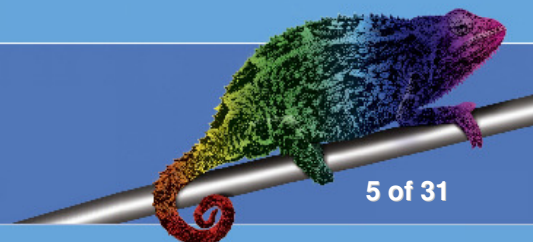

# SB6432

## Technical Datasheet



### *Improved Durability*

Over 3 million cycles for keyswitch element

### *Mounting Methods*

Socket pins and socket locks

### *Low Power Consumption*

Less than 65mA maximum current is needed when bright white backlighting is selected. Typical value is less than 25mA with one of the **RGB** colors.

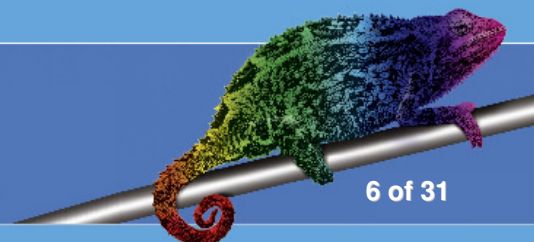



# Technical Overview

<i>Features</i>	<i>SB6432</i>
<b>Resolution</b>	64 x 32
<b>RGB backlight colors</b>	over 10,000 <b>RGB</b> colors
<b>Interfaces</b>	Synchronous serial 8-bit interfaces (custom protocols available upon request)
<b>External clock</b>	No external clock required
<b>Self-initialisation</b>	Yes
<b>Maximum speed</b>	2 MBaud
<b>Operating supply</b>	4.9 V to 5.1 V
<b>Keyswitch type</b>	tactile, 2.0 mm travel with over travel protection
<b>Keyswitch life time</b>	> 3.0 million cycles
<b>Contact resistance</b>	< 200 Ohm
<b>Operating temperature</b>	0°C to 55°C
<b>Storage temperature</b>	-20°C to 65°C

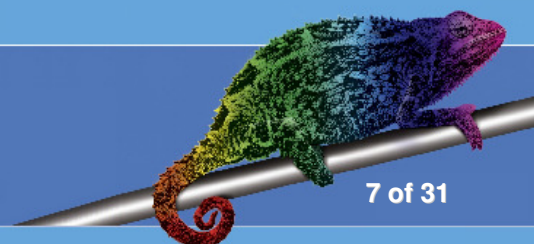

# SB6432

## Technical Datasheet



# SB6432

## Dimensions

Dimensions ( X x Y x Z )  
Screen size ( X x Y )

24.5 x 23.5 x 26.0 mm + / - 0,2 mm  
20.0 x 16.5 mm + / - 0.1 mm

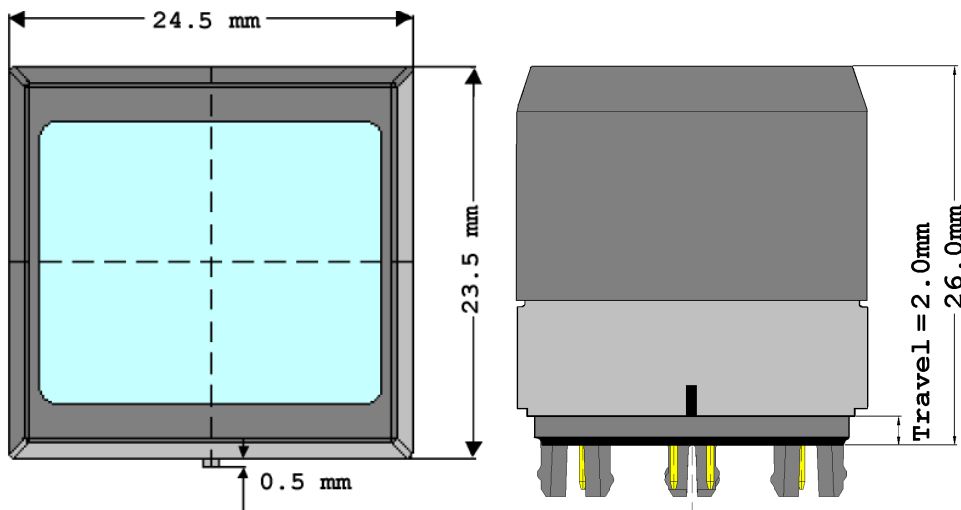

## Keyswitch

Key stroke  
Operation force:  
Over travel protection:  
Lifetime:

2.0 mm +/- 0.1 mm; tactile  
1.3 N +/- 0.2 N  
yes  
3 million cycles

Tactile Force Curve

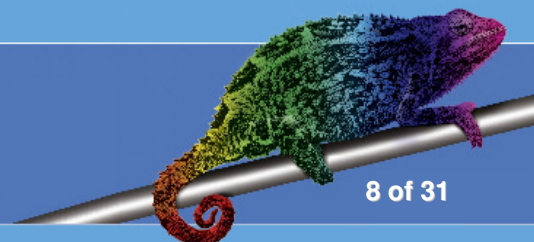
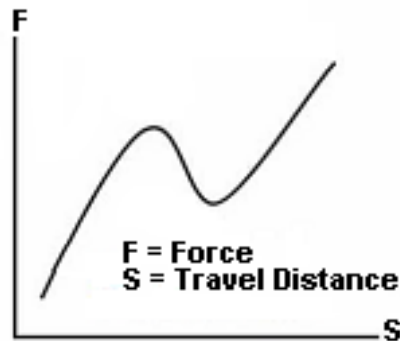





### Layout

**Direct PCB Mount  
(top view)**

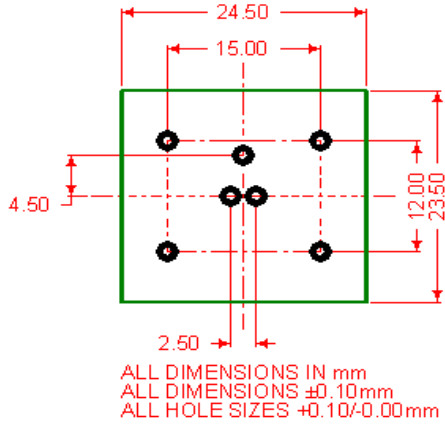

⊙  $\varnothing 1.00$  PTH HOLE x  $\varnothing 2.00$  PADS

**Socket Mount  
(top view)**

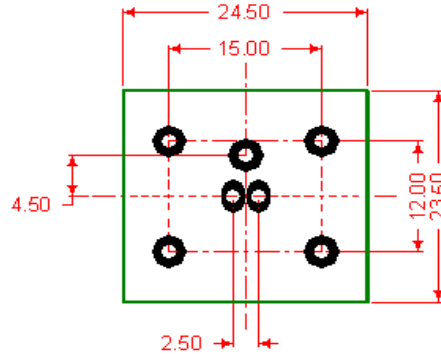

⊙  $\varnothing 1.50$  PTH HOLE x  $\varnothing 2.00 \times 3.20$  PADS  
⊙  $\varnothing 1.50$  PTH HOLE x  $\varnothing 3.20$  PADS

### Drill Masks

**for direct soldering  
(top view)**

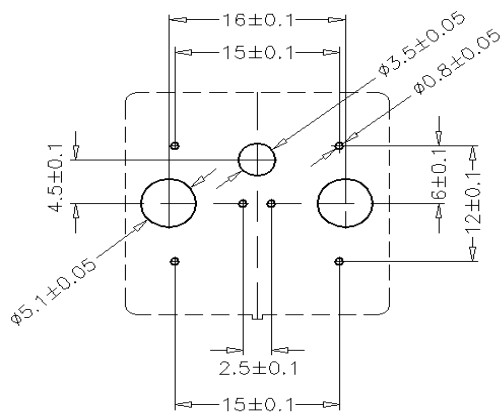

**for use with socket pins  
(top view)**

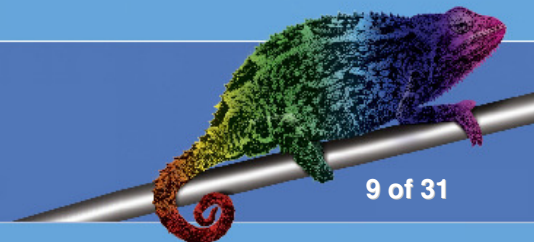
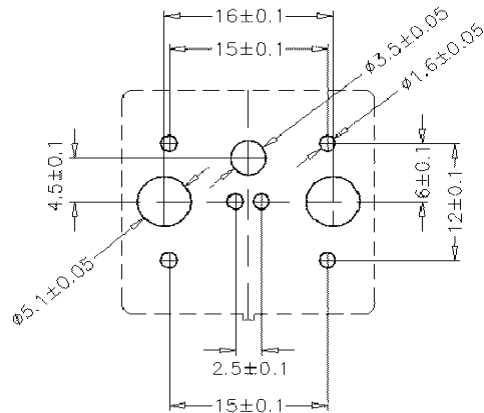



Recommended distance for array assembly is 1mm between each key.

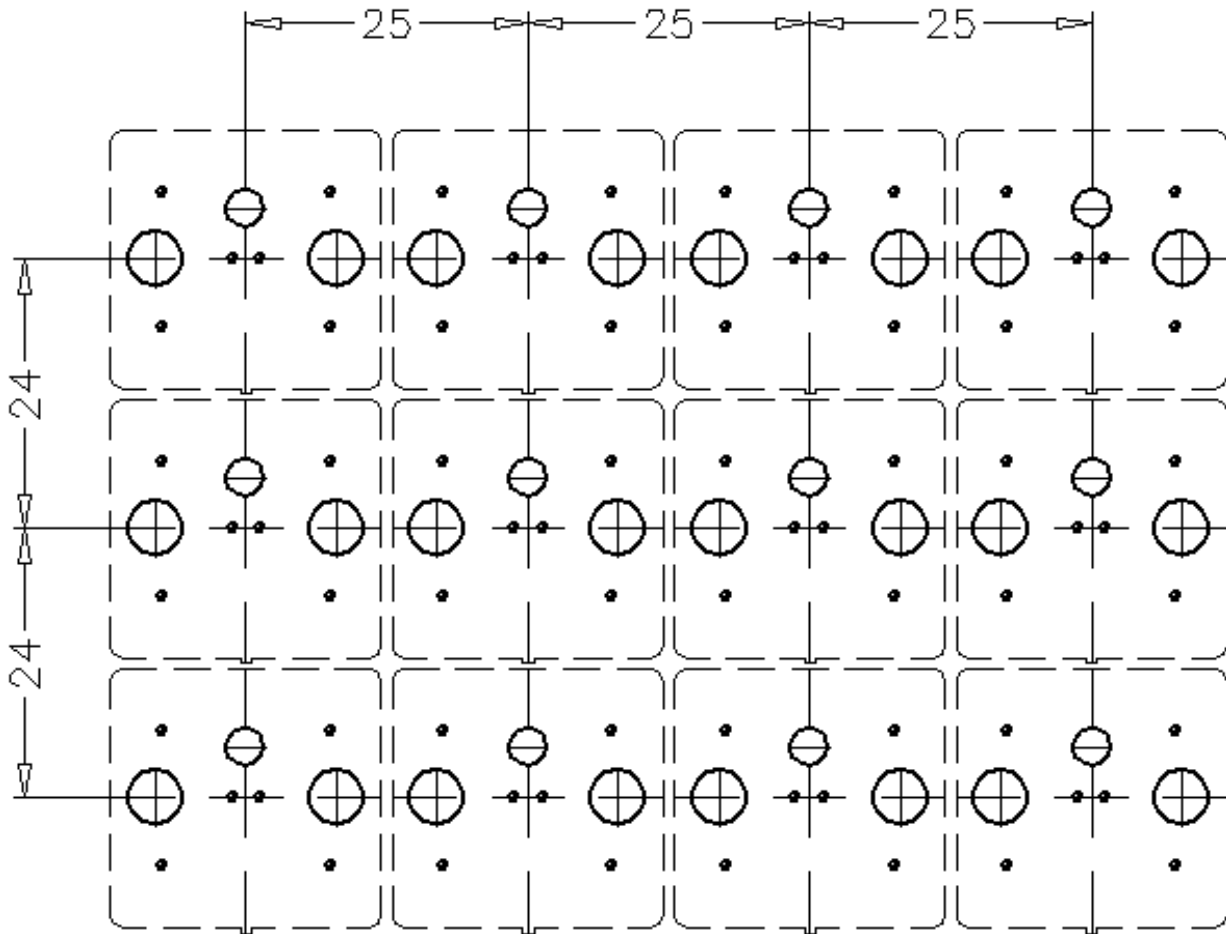

### Mounting Methods

Socket mountable (see corresponding Drill Mask). Socket pins (**SP0000**) are used for field-exchangeable mounting.

Through-hole mountable on PCBs with 1.6mm and 2.0mm thickness.

Manual soldering: max. 350° C for max. 3.5 seconds per pin

Wave soldering: 260° C for 10 seconds

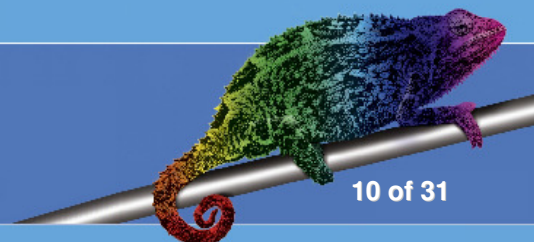

# SB6432

## Technical Datasheet



### Liquid Crystal Display

Screen Size (X x Y) 17.26 mm x 12.14 mm

Pixel Size (X x Y) **SB6432** 0.25 mm x 0.36 mm

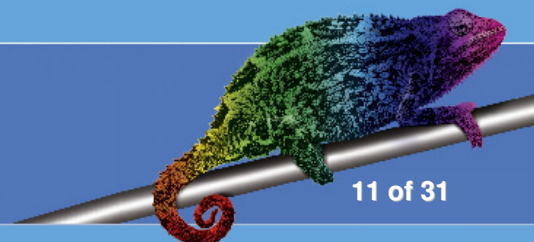
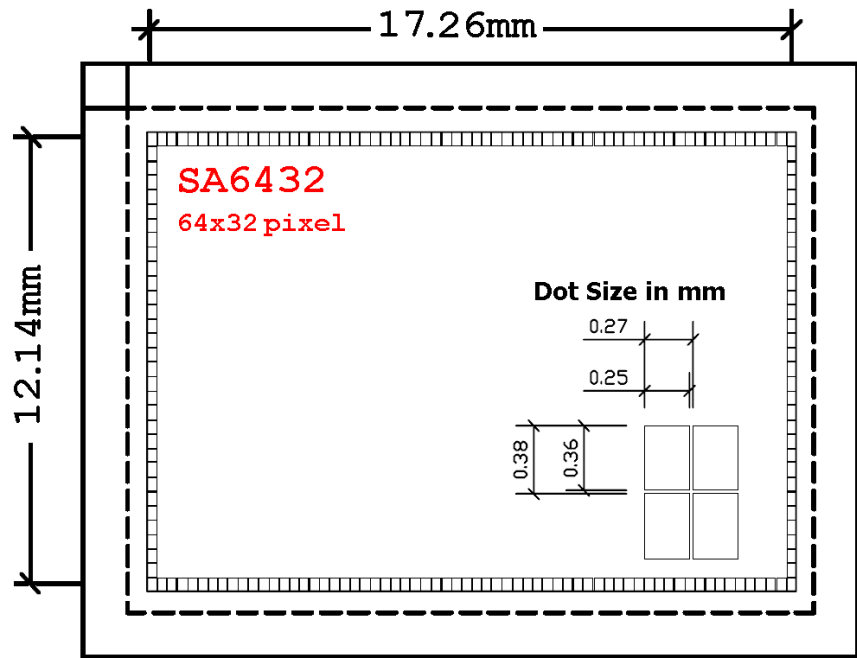



### Environmental Specifications

Operating temperature            0°C to 55°C  
 Storage temperature            -20°C to 65°C  
 Humidity                            up to 75% relative humidity at 65°C

### Electrical Specifications

Operating voltage                4.9 V to 5.1 V  
 Current consumption            max. 65 mA; typ. < 30 mA; min. 8 mA  
 Contact resistance              < 200 Ohm  
 Insulating resistance            > 100 MOhm

Symbol	Parameter	Min.	Typ.	Max.	Unit
V <sub>DD</sub> *1)	Operating voltage	4.9		5.1	V
I <sub>DD</sub> *2)	Supply current	8	<30	65	mA
V <sub>IN</sub>	Input voltage on any pin			V <sub>SS</sub> -0.3 - V <sub>DD</sub> +0.3	V
I <sub>DIO</sub>	Output data current sunk/source			+/- 5	mA
I <sub>CIO</sub>	Output clock current sunk/source			+/- 5	mA
V <sub>IL</sub>	Input low level voltage	V <sub>SS</sub> -0.3		0.3 x V <sub>DD</sub>	V
V <sub>IH</sub>	Input high level voltage	0.7 x V <sub>DD</sub>		V <sub>DD</sub> + 0.3	V
C <sub>CIO</sub>	I/O clock pin capacitance		10		pF
C <sub>DIO</sub> *3)	I/O data pin capacitance			30	pF

\*1) Voltage range to ensure proper display contrast restricted to 4.9V to 5.1V  
 \*2) Special power saving models available on request  
 \*3) The I/O data pin capacitance will be reduce in future products without notice.

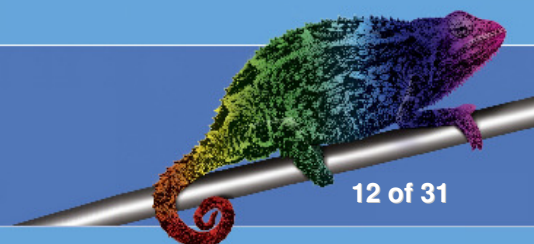



# Interfacing SB6432

## Contact Terminals

Pin	Symbol	Description	Comment
1	GND	negative (ground) power terminal	0.0 V
2	+ 5V	positive power terminal	+4.9 V – +5.1 V
3	CLOCK	clock line to synchronize data write and for internal use	60 kHz – 2 Mhz HIGH when inactive
4	DATA	command and data line to internal <i>Advanced Technology™</i> electronics	HIGH when inactive; see data format for details
5	SW1	switch contact	contact resistance < 200 Ohm
6	SW2	switch contact	contact resistance < 200 Ohm

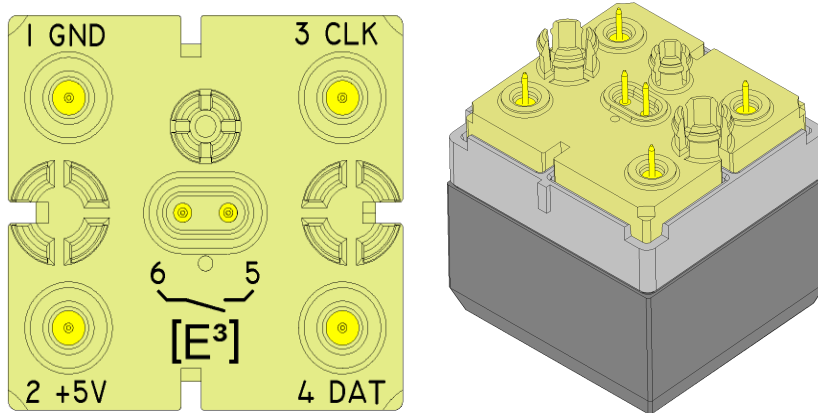

Pin View (terminal name and number are also marked on the keyswitch)

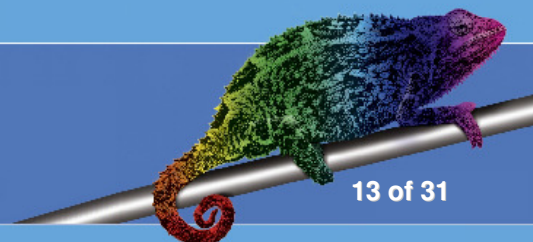



### Block Diagram

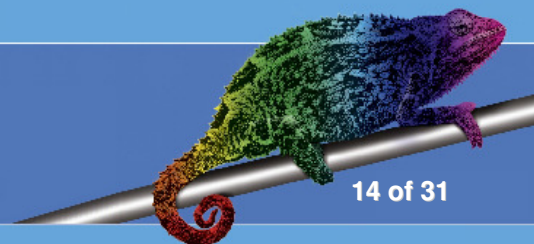
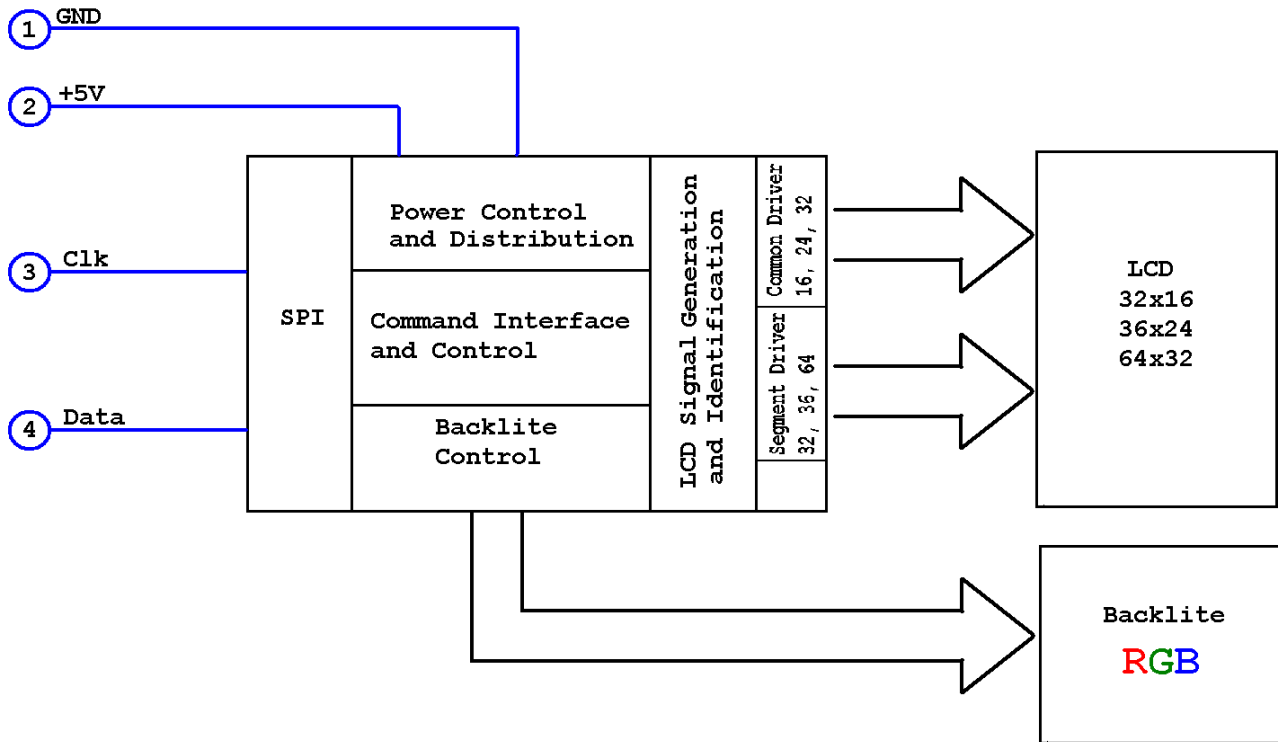



## Serial Protocols

The SB6432 keyswitches are connected to the controlling central processing unit by a 2 wire serial connection.

### The Advanced Technology™ Mode

Additional protocols are available upon request. Please contact your local [E<sup>3</sup>] distributor or [E<sup>3</sup>] directly at [techsupport@e3-keys.com](mailto:techsupport@e3-keys.com).

Feature	Advanced Technology™ Mode
Clock Frequency	up to 2 MHz
Permanent Clock	No
Data Word Size	8 bit
Internal Serial Number	Yes*

\* To take advantage of these advanced functions your hardware must ensure that the SA keys are actively driving the serial data lines in *Advanced Technology™* mode.

## LEGACY MODE™

*Legacy Mode™* is not supported in the SB switches.

*Legacy Mode™* is only supported in the SA3216 and SA3624 switches.

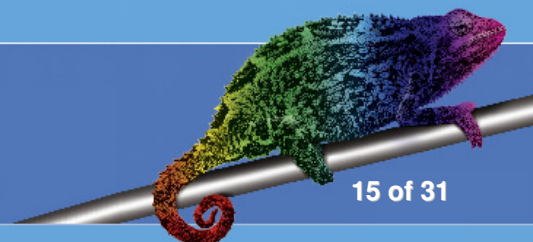



### ADVANCED TECHNOLOGY™ MODE

This is the standard mode for controlling SB keyswitches and provides full access to all capabilities of the SB6432 keys. The details of this control protocol are documented in the subsequent paragraphs

The **Advanced Technology™** Mode uses a conventional synchronous protocol. A permanently applied clock is not necessary. Please make sure that inactive Clock and Data are set to “high” state.

The only difference to a true 8-bit synchronous data transmission is that the data may also be synchronized to a permanently applied clock. No parity checking/generation is required.

Since it is possible that the clock is applied permanently a StartBit is required to be able to detect the start of a transmission. To allow for a StartBit in a standard synchronous SPI the MSB of the DataByte is to be set to 0.

### TIMING DIAGRAM

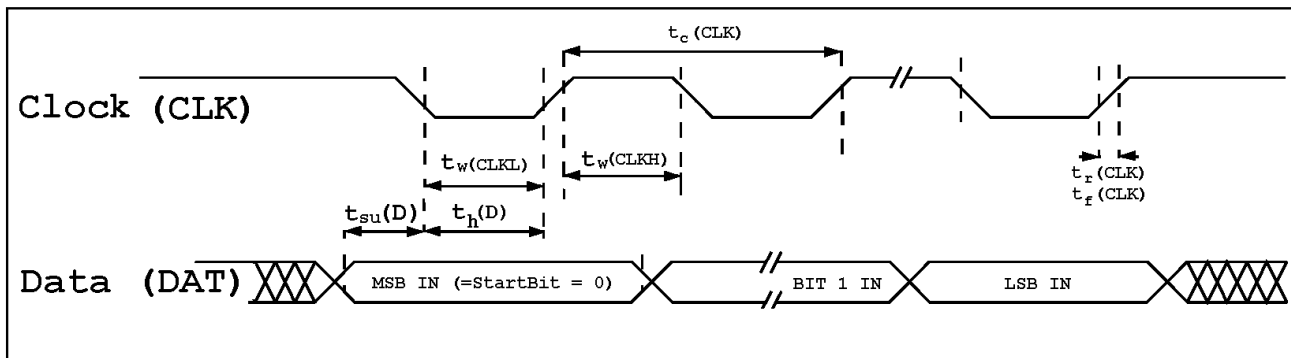

**Note: Clock and Data lines must be set to HIGH when inactive.**

Symbol	Parameter	Min	Max	Unit
$t_c(\text{CLK})$	SPI Clock frequency	0.06	2	MHz
$t_w(\text{CLKH})$	Clock high time	90		ns
$t_w(\text{CLKL})$	Clock low time	90		ns
$t_{su}(\text{D})$	Data input setup time	140		ns
$t_h(\text{D})$	Data input hold time	100		ns
$t_r(\text{CLK})$	Clock rise time	15		ns
$t_f(\text{CLK})$	Clock fall time		15	ns

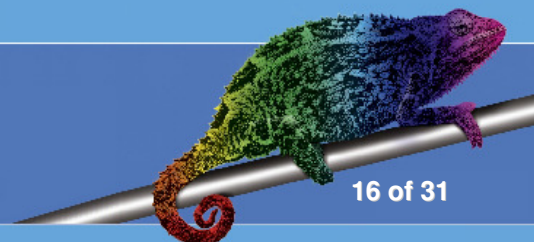





## Command Set

### SYNCHRONOUS PROTOCOL

The command structure is quite simple as you can see in the following table. Due to the possibility of a permanently applied clock each transmitted data must have a leading “0”. To distinguish between command and data the sixth bit is reserved. There are three sets of commands:

**Write Data to the LCD Display**

**Set Backlight Color**

**Extended Command Set (does not have leading “0” and does not allow for permanently applied clock)**

The first two command sets imply the required data and do not expect a return value from the key. Some commands in the Extended Command set, however, request information to be returned by the key. In this case, the Advanced Technology™ electronics will generate their own clock signal for the data transmission. For details on this scenario, see the **Applications Notes** on our website [www.e3-keys.com](http://www.e3-keys.com).

Note: If you are running the keys in a *Legacy Mode*™ environment you cannot use the extended commands since legacy systems do not support returning information from the keys. This may cause a hardware collision, which may result in damage to your system.

### COMMAND AND DATA FORMATS

<b>Command</b> <i>(binary representation)</i>	<b>Command Name / Description</b>	<b>Comments</b>
01xxxxxx	Command format	“xxxxxx” contains command values according to the Commands table on page 15.
00xxxxxx	Data format	Data to be sent to the key must always have bit 6 reset. <b>Note: All commands and data will have bit 7 reset in order to make the protocol compatible with systems having a permanently applied clock.</b>
xxxxxxx	Data format	8 Bit data words allowed if there is no permanent clock.

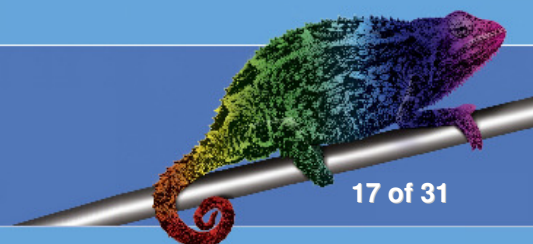



### COMMANDS FOR MIXED USE WITH/WITHOUT PERMANENT CLOCK

Command (binary representation)	Command Name / Description	Comments
01000000 (0x40)	<b>Set Display Address &amp; Write Display Data</b>	<p>All writes to the display must be initiated by this command. Address pointer is auto-incremented by data transmission.</p> <p>The command expects min. 4 data words to follow:            0000000A<sub>8</sub>            0000A<sub>7</sub>A<sub>6</sub>A<sub>5</sub>A<sub>4</sub>            0000A<sub>3</sub>A<sub>2</sub>A<sub>1</sub>A<sub>0</sub>            0000D<sub>3</sub>D<sub>2</sub>D<sub>1</sub>D<sub>0</sub></p> <p><b>Multiple Data Bytes may follow without additional addressing in one sequence since the controller will perform auto-increment</b></p> <p>Details are found in the Bit/Pixel Mapping tables on pages 25.</p>
01000001 (0x41)	<b>Set Colour</b>	<p>There is one data word to follow:            00R<sub>1</sub>R<sub>0</sub>G<sub>1</sub>G<sub>0</sub>B<sub>1</sub>B<sub>0</sub></p>
01000010 (0x42)	<b>Set RGB Colour</b>	<p>There are 3 data bytes to follow:            0D<sub>6</sub>D<sub>5</sub>D<sub>4</sub>D<sub>3</sub>D<sub>2</sub>D<sub>1</sub>D<sub>0</sub>            0D<sub>6</sub>D<sub>5</sub>D<sub>4</sub>D<sub>3</sub>D<sub>2</sub>D<sub>1</sub>D<sub>0</sub>            0D<sub>6</sub>D<sub>5</sub>D<sub>4</sub>D<sub>3</sub>D<sub>2</sub>D<sub>1</sub>D<sub>0</sub></p> <p><b>Note:</b> The lower 10 values on each colour brightness value should only be used for single colour applications due to restrictions in the colour calibration.</p> <p>These colors may change and should be used with caution until otherwise noted by [E<sup>3</sup>]</p>
01000011 (0x43)	<b>End Transmission</b>	<p>Ends data transmission to keys and awaits next command sequence. Transmitted commands are begin processed and displayed.</p> <p>This command should be sent after each sequence.</p> <p><b>Note:</b> The key will not respond to any command issued within 50μs after this command.</p>

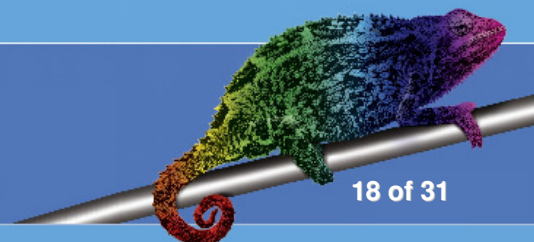

# SB6432

## Technical Datasheet



01000100 (0x44)	<b>Read Keyswitch ID</b> THIS COMMAND FORCES THE KEYSWITCH TO ANSWER ON THE CLOCK AND DATA LINE. (The clock is generated by the SA switch; see Application Notes at <a href="http://www.e3-keys.com">www.e3-keys.com</a> )	The answer is consisting of ASCII characters representing the Keyswitch ID and is terminated with CR (0x0D):  <b>SB6432</b>
01000101 (0x45)	<b>Read Serial Number</b> THIS COMMAND FORCES THE KEYSWITCH TO ANSWER ON THE CLOCK AND DATA LINE. (The clock is generated by the SA switch; see Application Notes at <a href="http://www.e3-keys.com">www.e3-keys.com</a> )	The answer is consisting of 4 Bytes which give the serial Number in the following format and is terminated with CR (0x0D): <b>SNYYWW#####</b> Year (04-99) Week (01-52) Number (00000 .. 99999)

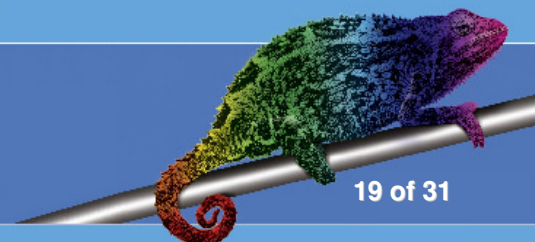



### ADDITIONAL COMMANDS ONLY AVAILABLE IN KEYS WITH ENHANCED COMMAND SET

<b>Command</b> <i>binary representation</i> <i>(hex representation)</i>	<b>Command Name / Description</b>	<b>Comments</b>
01000111, 00000000 (0x47), (0x00)	<b>Extended command, NOOP</b>	No Operation
01000111, 00000001, D <sub>7</sub> D <sub>6</sub> D <sub>5</sub> D <sub>4</sub> D <sub>3</sub> D <sub>2</sub> D <sub>1</sub> D <sub>0</sub> (0x47), (0x01), (0xXX)	<b>Extended command, SetMode *2)</b>	<p>The Display and/or backlight is enabled/disabled while the bitmap data is maintained</p> <p>D<sub>7</sub>: =1 set Group / =0 only if group matches</p> <p>D<sub>6</sub>: =1 Display ON* / =0 Display OFF</p> <p>D<sub>5</sub>: =1 Backlite ON* / =0 Backlite OFF</p> <p>D<sub>4</sub>: Reserve</p> <p>D<sub>3..0</sub> Group Number</p> <p><b>Note:</b> D<sub>7</sub>=1 does not only specify group, but executes command as well</p> <p><b>Note2:</b> Please allow for 2μsec pause as this command has to be performed immediately</p>
01000111, 00000010, D <sub>7</sub> D <sub>6</sub> D <sub>5</sub> D <sub>4</sub> D <sub>3</sub> D <sub>2</sub> D <sub>1</sub> D <sub>0</sub>  (0x47), (0x02), (0xXX)	<b>Extended command, SetDisplayParam*</b>	<p>This command overwrites the standard setting for the display. Under certain circumstances it may be required to adjust some settings of the display.</p> <p>D<sub>4</sub> : BIAS</p> <p>D<sub>3,2</sub>: LCD Refresh rate</p> <p>D<sub>1,0</sub>: LCD Drive current</p> <p><b>Note:</b> Setting will be reset after power on and or if there is a incorrect data transmission detected</p>

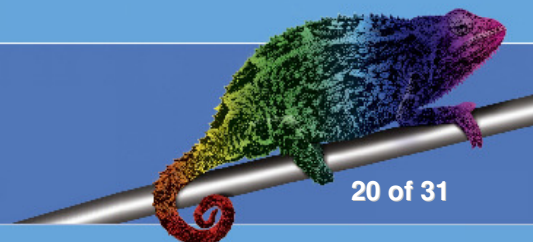



<p>01000111, 01111111, 11111111, 256 x Pixel Bytes  (0x47), (0x7F), (0xFF), 256 x D<sub>7</sub>D<sub>6</sub>D<sub>5</sub>D<sub>4</sub>D<sub>3</sub>D<sub>2</sub>D<sub>1</sub>D<sub>0</sub></p>	<p><b>Extended command, Write Display Data</b></p>	<p>The display is completely rewritten. 256 bytes of pixel data must follow. First byte is written to Pixel Position 0, as shown in “Bit/Pixel Mapping Table for SA6432 in 8bit enhanced mode”</p> <p><b>D<sub>7</sub>D<sub>6</sub>D<sub>5</sub>D<sub>4</sub>D<sub>3</sub>D<sub>2</sub>D<sub>1</sub>D<sub>0</sub></b></p> <p><b>Note: The amount of Data Bytes must exactly match 256.</b></p> <p><b>Note: status of display on/off is unaffected.</b></p>
--	--	--

\* Detailed instruction for use will be available on request. Under normal working conditions there is no need for adjustment.

\*<sup>2</sup>) **Group settings will be lost after power off**

**Please note:** Enhanced commands are only possible if there is no permanently applied clock.

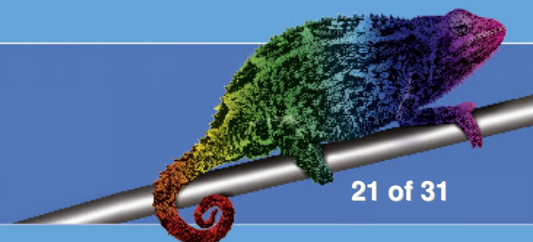



### COMMAND EXAMPLES

Set display address to point to upper right corner of display:

01000000 00000000 00000000 00000000 (0x40 0x00 0x00 0x00)

Write Data to Display

Binary	HEX	Comments
01000000	0x40	Set display address & Write to Display
00000000	0x00	Data: 00000 for <b>A<sub>8</sub></b>
00000000	0x00	Data: 00000 for <b>A<sub>7</sub>A<sub>6</sub>A<sub>5</sub>A<sub>4</sub></b>
00000000	0x00	Data: 00000 for <b>A<sub>3</sub>A<sub>2</sub>A<sub>1</sub>A<sub>0</sub></b>
00000101	0x05	Write pattern 0101 to LCD Display and increment address by 1
00000101	0x05	Write pattern 0101 to LCD Display and increment address by 1
00000101	0x05	Write pattern 0101 to LCD Display and increment address by 1
00000101	0x05	Write pattern 0101 to LCD Display and increment address by 1

Set backlighting color to light orange:

01000001 00111000 ( 0x41 0x38)

Binary	HEX	Comments
01000001	0x41	Set color
00111000	0x38	<b>Red</b> : high intensity, <b>Green</b> medium intensity, <b>Blue</b> off

The 2 individual bits for each color intensity have the following structure:

00 = off  
 01 = low  
 10 = medium  
 11 = high

End transmission and process data:

01000011 (0x43)

Binary	HEX	Comments
01000011	0x43	End transmission

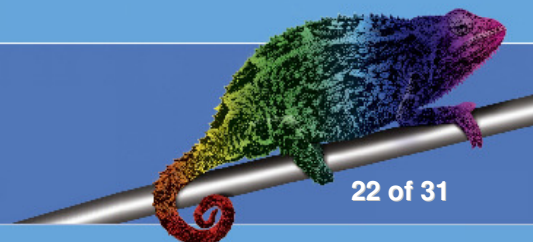

# SB6432

## Technical Datasheet



Read Keyswitch ID: 01001000 (0x48)		
Binary	HEX	Comments
01001000	0x48	Read Keyswitch ID
The Key will answer by generating its own clock and data signals (see <b>Application Notes</b> at <a href="http://www.e3-keys.com">www.e3-keys.com</a> for details)		
The following examples show the answers for the different SAxxxx types: 0x53 0x42 0x36 0x34 0x33 0x32 0x0D = SB6432 CR		

Read Serial Number: 01001001 (0x49)		
Binary	HEX	Comments
01001001	0x49	Read Serial Number (SNYYWW#####)
The Key will answer by generating its own clock and data signals (see <b>Application Notes</b> at <a href="http://www.e3-keys.com">www.e3-keys.com</a> for details)		
The following example shows the format of the answer: 0x53 0x4E 0x30 0x34 0x30 0x33 0x30 0x35 0x30 0x39 0x33 0x0D = SN040305093CR		

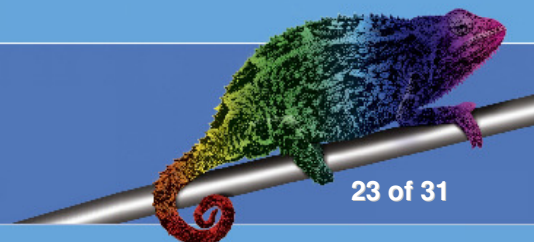



## BIT / PIXEL MAPPING

### Display Memory – Internal RAM Structure

The static display RAM holds the data for the LCD display. This data is displayed automatically and is continuously refreshed without further interference from the host controller.

The display RAM is organized into 512 x 4 bits and stores the display data in the SB switch. The content of the display RAM is mapped directly to the LCD display. This RAM can be accessed by the Write LCD Data command, which must be preceded by the Set LCD Address command. The SET LCD Address command tells the key where to write the data and where to display it on the LCD. For actual RAM-Display mapping please refer to the corresponding Bit/Pixel mapping tables below.

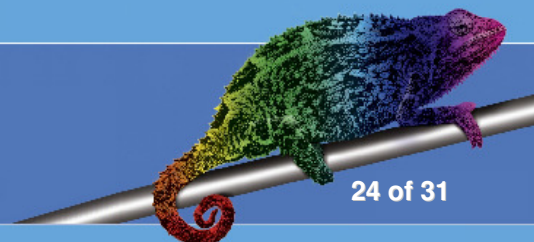



# SB6432

## Technical Datasheet



### Bit/Pixel Mapping Table for SB6432

	Column 63	Column 62	Column 61	Column 60	...	Column 3	Column 2	Column 1	Column 0
Address	1FCH	1F4H	1ECH	1E4H	...	1CH	14H	0CH	04H
Row 16	D <sub>0</sub>	D <sub>0</sub>	D <sub>0</sub>	D <sub>0</sub>	...	D <sub>0</sub>	D <sub>0</sub>	D <sub>0</sub>	D <sub>0</sub>
Row 17	D <sub>1</sub>	D <sub>1</sub>	D <sub>1</sub>	D <sub>1</sub>	...	D <sub>1</sub>	D <sub>1</sub>	D <sub>1</sub>	D <sub>1</sub>
Row 18	D <sub>2</sub>	D <sub>2</sub>	D <sub>2</sub>	D <sub>2</sub>	...	D <sub>2</sub>	D <sub>2</sub>	D <sub>2</sub>	D <sub>2</sub>
Row 19	D <sub>3</sub>	D <sub>3</sub>	D <sub>3</sub>	D <sub>3</sub>	...	D <sub>3</sub>	D <sub>3</sub>	D <sub>3</sub>	D <sub>3</sub>
Address	1FDH	1F5H	1EDH	1E5H	...	1DH	15H	0DH	05H
Row 20	D <sub>0</sub>	D <sub>0</sub>	D <sub>0</sub>	D <sub>0</sub>	...	D <sub>0</sub>	D <sub>0</sub>	D <sub>0</sub>	D <sub>0</sub>
Row 21	D <sub>1</sub>	D <sub>1</sub>	D <sub>1</sub>	D <sub>1</sub>	...	D <sub>1</sub>	D <sub>1</sub>	D <sub>1</sub>	D <sub>1</sub>
Row 22	D <sub>2</sub>	D <sub>2</sub>	D <sub>2</sub>	D <sub>2</sub>	...	D <sub>2</sub>	D <sub>2</sub>	D <sub>2</sub>	D <sub>2</sub>
Row 23	D <sub>3</sub>	D <sub>3</sub>	D <sub>3</sub>	D <sub>3</sub>	...	D <sub>3</sub>	D <sub>3</sub>	D <sub>3</sub>	D <sub>3</sub>
Address	1FEH	1F6H	1EEH	1E6H	...	1EH	16H	0EH	06H
Row 24	D <sub>0</sub>	D <sub>0</sub>	D <sub>0</sub>	D <sub>0</sub>	...	D <sub>0</sub>	D <sub>0</sub>	D <sub>0</sub>	D <sub>0</sub>
Row 25	D <sub>1</sub>	D <sub>1</sub>	D <sub>1</sub>	D <sub>1</sub>	...	D <sub>1</sub>	D <sub>1</sub>	D <sub>1</sub>	D <sub>1</sub>
Row 26	D <sub>2</sub>	D <sub>2</sub>	D <sub>2</sub>	D <sub>2</sub>	...	D <sub>2</sub>	D <sub>2</sub>	D <sub>2</sub>	D <sub>2</sub>
Row 27	D <sub>3</sub>	D <sub>3</sub>	D <sub>3</sub>	D <sub>3</sub>	...	D <sub>3</sub>	D <sub>3</sub>	D <sub>3</sub>	D <sub>3</sub>
Address	1FFH	1F7H	1EFH	1E7H	...	1FH	17H	0FH	07H
Row 28	D <sub>0</sub>	D <sub>0</sub>	D <sub>0</sub>	D <sub>0</sub>	...	D <sub>0</sub>	D <sub>0</sub>	D <sub>0</sub>	D <sub>0</sub>
Row 29	D <sub>1</sub>	D <sub>1</sub>	D <sub>1</sub>	D <sub>1</sub>	...	D <sub>1</sub>	D <sub>1</sub>	D <sub>1</sub>	D <sub>1</sub>
Row 30	D <sub>2</sub>	D <sub>2</sub>	D <sub>2</sub>	D <sub>2</sub>	...	D <sub>2</sub>	D <sub>2</sub>	D <sub>2</sub>	D <sub>2</sub>
Row 31	D <sub>3</sub>	D <sub>3</sub>	D <sub>3</sub>	D <sub>3</sub>	...	D <sub>3</sub>	D <sub>3</sub>	D <sub>3</sub>	D <sub>3</sub>
Address	1F8H	1F0H	1E8H	1E0H	...	18H	10H	08H	00H
Row 0	D <sub>0</sub>	D <sub>0</sub>	D <sub>0</sub>	D <sub>0</sub>	...	D <sub>0</sub>	D <sub>0</sub>	D <sub>0</sub>	D <sub>0</sub>
Row 1	D <sub>1</sub>	D <sub>1</sub>	D <sub>1</sub>	D <sub>1</sub>	...	D <sub>1</sub>	D <sub>1</sub>	D <sub>1</sub>	D <sub>1</sub>
Row 2	D <sub>2</sub>	D <sub>2</sub>	D <sub>2</sub>	D <sub>2</sub>	...	D <sub>2</sub>	D <sub>2</sub>	D <sub>2</sub>	D <sub>2</sub>
Row 3	D <sub>3</sub>	D <sub>3</sub>	D <sub>3</sub>	D <sub>3</sub>	...	D <sub>3</sub>	D <sub>3</sub>	D <sub>3</sub>	D <sub>3</sub>
Address	1F9H	1F1H	1E9H	1E1H	...	19H	11H	09H	01H
Row 4	D <sub>0</sub>	D <sub>0</sub>	D <sub>0</sub>	D <sub>0</sub>	...	D <sub>0</sub>	D <sub>0</sub>	D <sub>0</sub>	D <sub>0</sub>
Row 5	D <sub>1</sub>	D <sub>1</sub>	D <sub>1</sub>	D <sub>1</sub>	...	D <sub>1</sub>	D <sub>1</sub>	D <sub>1</sub>	D <sub>1</sub>
Row 6	D <sub>2</sub>	D <sub>2</sub>	D <sub>2</sub>	D <sub>2</sub>	...	D <sub>2</sub>	D <sub>2</sub>	D <sub>2</sub>	D <sub>2</sub>
Row 7	D <sub>3</sub>	D <sub>3</sub>	D <sub>3</sub>	D <sub>3</sub>	...	D <sub>3</sub>	D <sub>3</sub>	D <sub>3</sub>	D <sub>3</sub>
Address	1FAH	1F2H	1EAH	1E2H	...	1AH	12H	0AH	02H
Row 8	D <sub>0</sub>	D <sub>0</sub>	D <sub>0</sub>	D <sub>0</sub>	...	D <sub>0</sub>	D <sub>0</sub>	D <sub>0</sub>	D <sub>0</sub>
Row 9	D <sub>1</sub>	D <sub>1</sub>	D <sub>1</sub>	D <sub>1</sub>	...	D <sub>1</sub>	D <sub>1</sub>	D <sub>1</sub>	D <sub>1</sub>
Row 10	D <sub>2</sub>	D <sub>2</sub>	D <sub>2</sub>	D <sub>2</sub>	...	D <sub>2</sub>	D <sub>2</sub>	D <sub>2</sub>	D <sub>2</sub>
Row 11	D <sub>3</sub>	D <sub>3</sub>	D <sub>3</sub>	D <sub>3</sub>	...	D <sub>3</sub>	D <sub>3</sub>	D <sub>3</sub>	D <sub>3</sub>
Address	1FBH	1F3H	1EBH	1E3H	...	1BH	13H	0BH	03H
Row 12	D <sub>0</sub>	D <sub>0</sub>	D <sub>0</sub>	D <sub>0</sub>	...	D <sub>0</sub>	D <sub>0</sub>	D <sub>0</sub>	D <sub>0</sub>
Row 13	D <sub>1</sub>	D <sub>1</sub>	D <sub>1</sub>	D <sub>1</sub>	...	D <sub>1</sub>	D <sub>1</sub>	D <sub>1</sub>	D <sub>1</sub>
Row 14	D <sub>2</sub>	D <sub>2</sub>	D <sub>2</sub>	D <sub>2</sub>	...	D <sub>2</sub>	D <sub>2</sub>	D <sub>2</sub>	D <sub>2</sub>
Row 15	D <sub>3</sub>	D <sub>3</sub>	D <sub>3</sub>	D <sub>3</sub>	...	D <sub>3</sub>	D <sub>3</sub>	D <sub>3</sub>	D <sub>3</sub>

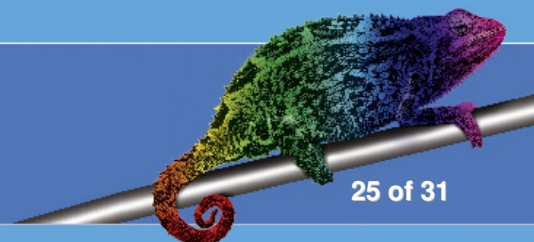



# Controlling SB Switch Arrays

Below are sample schematics for controlling one or sixteen SB keyswitches in an array using a PIC16F62X controller to illustrate the simplicity of the control circuitry. Further descriptions including sources are available under the **Application Notes** at our website at [www.e3-keys.com](http://www.e3-keys.com).

For additional technical support with your own design implementation, please contact your local [E<sup>3</sup>] distributor or [E<sup>3</sup>] at [techsupport@e3-keys.com](mailto:techsupport@e3-keys.com).

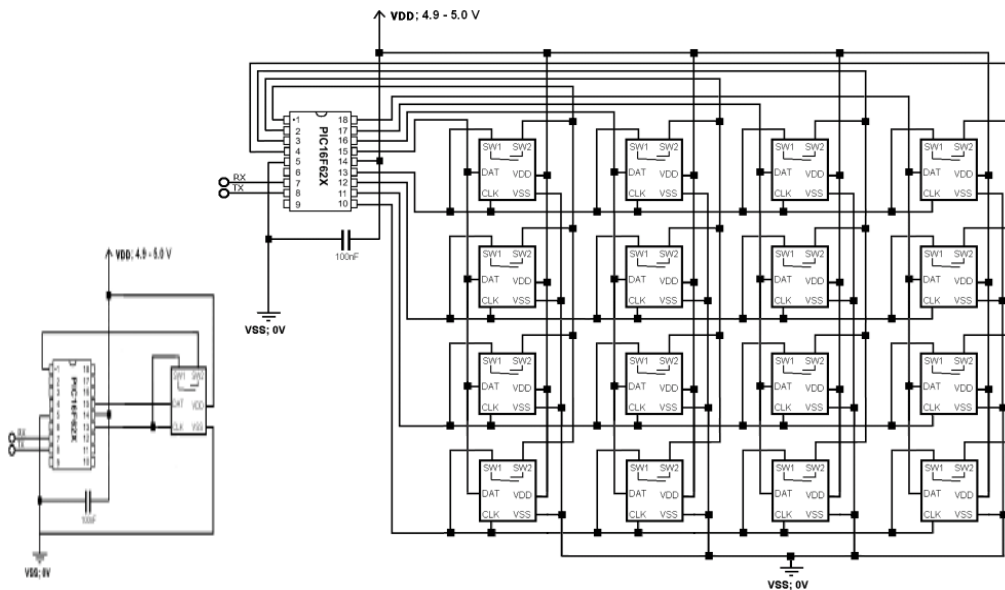

In the above examples the clock and data signals are generated on the corresponding I/O pins of the PIC controller.

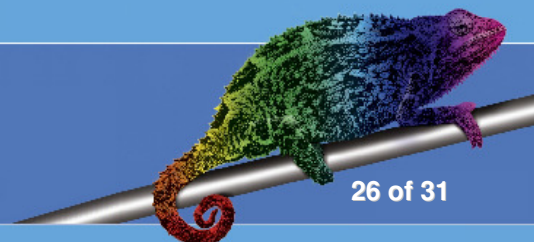



## Order Information

<i>Part Number</i>	<i>Description</i>
<b>SB6432-B</b>	SB pushbutton keyswitch with 64 x 32 pixel display Backlit in 64 RGB colors Black housing (RAL 9005)
<b>SP0000</b>	Socket pin set for use with the Snxxxx switches
<b>DS0000</b>	DemoBoard for use with 2 Sxxxxx keys with RS232 interface Keys are not included. Full documentation and software available at <a href="http://www.e3-keys.com">www.e3-keys.com</a> .

Other housing colors available on request

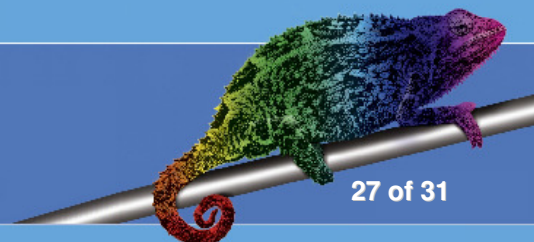



## Change History

<i>Version</i>	<i>Date</i>	<i>Comments</i>
0.1	02/22/06	Initial draft document
0.2	03/02/06	Revised and released as PRELIMINARY
1.0	03/28/06	Release version
1.1	07/10/07	I/O data pin capacitance value changed
1.2	03/18/08	SB, Sxnnnn nomenclatur corrected

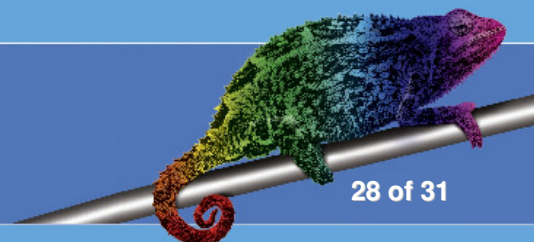



# Notices

## Copyright Notice

© 2006–2008 Copyright [E<sup>3</sup>] Engstler Elektronik Entwicklung GmbH. All rights reserved.

[E<sup>3</sup>], *The Third Evolution*<sup>™</sup> and *Legacy Mode*<sup>™</sup> are trademarks of [E<sup>3</sup>]. *The Keys to Intelligence*<sup>™</sup> is a trademark of I/O Universal Technologies, Inc. used with permission. All other trademarks are property of their respective owners.

No part of this publication may be copied, photocopied, reproduced, translated or reduced to any electronic medium or machine-readable form without the expressed written consent of [E<sup>3</sup>] Engstler Elektronik Entwicklung GmbH.

## Technical Notices

This datasheet is intended for technically qualified personnel trained in the field of electronics.

The knowledge of electronics and the technically correct implementation of the content of this datasheet are required for problem free installation, implementation and safe operation of the described product. Only qualified personnel have the required know-how to implement the specifications given in this data sheet.

For clarity, not all details regarding the product or its implementation, installation, operation, or maintenance have been included. Should you require additional information or further assistance, please contact your local [E<sup>3</sup>] distributor or [E<sup>3</sup>] Engstler Elektronik Entwicklung GmbH at [techsupport@e3-keys.com](mailto:techsupport@e3-keys.com). You may also visit our website at [www.e3-keys.com](http://www.e3-keys.com).

## Life Support Applications

The products discussed in this document are not designed for use in life support appliances, devices, or systems where malfunction of these products can reasonably be expected to result in personal injury. [E<sup>3</sup>] customers using or selling these products for use in such applications do so at their own risk and agree to fully indemnify [E<sup>3</sup>] for any damages resulting from such improper use or sale.

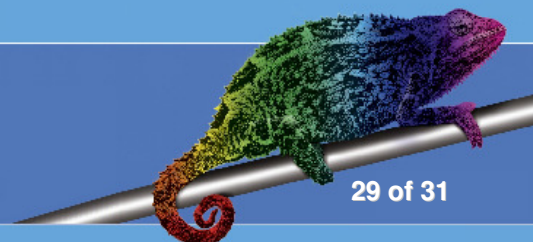



## Flammability Ratings

The SB6432 base is rated UL94-V0; all other plastics are rated UL94-HB.

## Warranty Disclaimer

[E<sup>3</sup>] ENGSTLER ELEKTRONIK ENTWICKLUNG GMBH grants no warranty with respect to this data sheet, neither explicit nor implied, and it is not liable for direct or indirect damages. Some states do not grant the exclusion of incidental or consequential damages and, therefore, this statement may not be valid in such cases.

This data sheet has been produced with all due care. However, since errors cannot be excluded, [E<sup>3</sup>] Engstler Elektronik Entwicklung GmbH does not grant any warranty or accept any legal responsibility or liability in any form for erroneous statements herein.

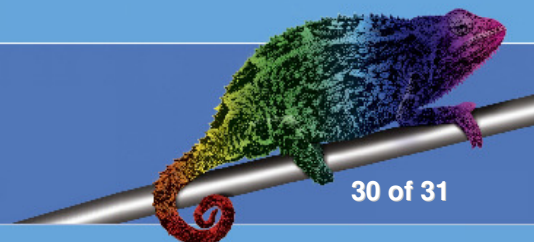



# Contact Information

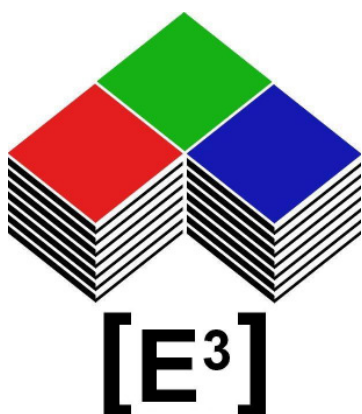

[E<sup>3</sup>]  
Engstler  
Elektronik  
Entwicklung  
GmbH

Industriering 7  
63868 Grosswallstadt  
Germany

Phone: +49 (0) 6022 262570  
Fax: +49 (0) 6022 262571  
E-Mail: [info@e3-keys.com](mailto:info@e3-keys.com)

